

**Dimensions Multi-turn actuators with 3-phase AC motors**

with AUMA plug/socket connector

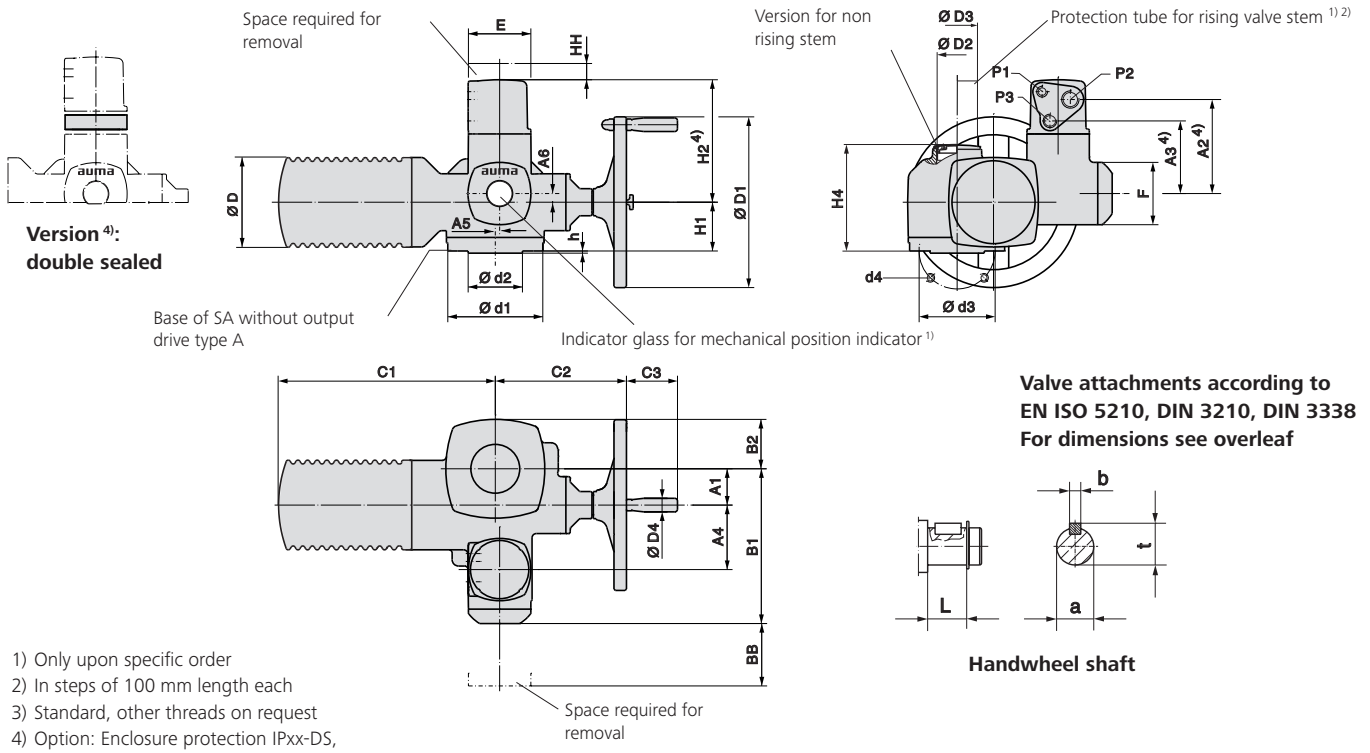

- 1) Only upon specific order
- 2) In steps of 100 mm length each
- 3) Standard, other threads on request
- 4) Option: Enclosure protection IPxx-DS, cover for electrical connection with additional frame

Dimensions	SA 07.2/SAR 07.2		SA 07.6/SAR 07.6		SA 10.2/SAR 10.2	SA14.2/SAR14.2	SA 14.6/SAR14.6	SA 16.2/SAR 16.2
	F07	F10 (G0)	F07	F10 (G0)	F10 (G0)	F14 (G1/2)	F14 (G1/2)	F16 (G3)
EN ISO 5210 (DIN3210)								
A1	40		40		50	67	67	80
A2 <sup>4)</sup>	174 (201 <sup>4)</sup> )		174 (201 <sup>4)</sup> )		174 (201 <sup>4)</sup> )	174 (201 <sup>4)</sup> )	174 (201 <sup>4)</sup> )	174 (201 <sup>4)</sup> )
A3 <sup>4)</sup>	134 (161 <sup>4)</sup> )		134 (161 <sup>4)</sup> )		134 (161 <sup>4)</sup> )	134 (161 <sup>4)</sup> )	134 (161 <sup>4)</sup> )	134 (161 <sup>4)</sup> )
A4	103		103		103	119	119	123.5
A5	-		-		-	8	8	15
A6	-		-		-	16	16	20
B1	238		238		248	286	286	303
B2	62		62		65	91	91	117
C1	265		265		283	389	389	430
C2	186		186		191	242	245	271
C3	63		63		63	94	94	94
Ø D	101		101		121	153	153	190
Ø D1	160		160		200	315	400	500
Ø D2	G 1¼"		G 1¼"		G 2"	G 2½"	G 2½"	G 3"
Ø D3	42 x 3.3		42 x 3.3		60 x 3.7	76 x 3.7	76 x 3.7	89 x 4.1
Ø D4	20		20		20	25	25	25
E	115		115		115	115	115	115
F	115		115		115	115	115	115
H1	78		78		80	90	90	110
H2 <sup>4)</sup>	210 (237 <sup>4)</sup> )		210 (237 <sup>4)</sup> )		210 (237 <sup>4)</sup> )	226 (253 <sup>4)</sup> )	226 (253 <sup>4)</sup> )	230 (257 <sup>4)</sup> )
H4	160		160		170	196	196	235
L	20		20		24	38.8	45.8	45.8
P1 <sup>3)</sup>	M20 x 1.5		M20 x 1.5		M20 x 1.5	M20 x 1.5	M20 x 1.5	M20 x 1.5
P2 <sup>3)</sup>	M32 x 1.5		M32 x 1.5		M32 x 1.5	M32 x 1.5	M32 x 1.5	M32 x 1.5
P3 <sup>3)</sup>	M25 x 1.5		M25 x 1.5		M25 x 1.5	M25 x 1.5	M25 x 1.5	M25 x 1.5
BB min.	180		180		180	180	180	180
HH min.	30		30		30	30	30	30
Ø a	20 d7		20 d7		20 d7	30 d7	30 d7	30 d7
b	6		6		6	8	8	8
Ø d1	90	125	90	125	125	175	175	210
Ø d2	55	70 (60)	55	70 (60)	70 (60)	100	100	130
Ø d3	70	102	70	102	102	140	140	165
d4	4 x M8	4 x M10	4 x M8	4 x M10	4 x M10	4 x M16	4 x M16	4 x M20
h	3		3		3	4	4	5
t	22.5		22.5		22.5	33	33	33

We reserve the right to alter data according to improvements made. Previous documents become invalid with the issue of this document.

Dimensions Valve attachments according to EN ISO 5210, DIN 3338, DIN 3210

Stem nut

Type  
EN ISO 5210 **A**  
DIN 3210 **A**

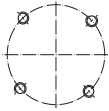

Arrangement of holes d4

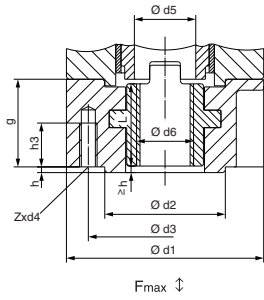

Dimensions		SA 07.2/SA 07.6			SA 10.2		SA 14.2/SA 14.6		SA 16.2	
EN ISO 5210	DIN 3210	F07	F10	G0	F10	G0	F14	G1/2	F16	G3
F max. kN		40	40	40	70	70	160		250	
Ø d1		90	125	125	125	125	175		210	
Ø d2		55	70	60	70	60	100		130	
Ø d3		70	102	102	102	102	140		165	
d4		M8	M10	M10	M10	M10	M16		M20	
Ø d5		35	36	36	44	44	62		80	
Ø d6 max. <sup>5)</sup>		26	34	34	40	40	57		75	
g		40	50	50	50	50	65		80	
h		3	3	3	3	3	4		5	
h3		12	15	15	15	15	25		35	
L		37	47	47	47	47	60		75	
Z		4	4	4	4	4	4		4	
Gewicht kg		1.1	2.8	2.8	2.8	2.8	6.8		11.7	

Output drive sleeve<sup>3)</sup>

Type  
EN ISO 5210 **B 1** = Ø d7 (b7/t7)  
DIN 3210 **B** = Ø d7 (b7/t7)  
EN ISO 5210 **B 2** < Ø d7 > Ø dy  
EN ISO 5210 **B 3** = Ø d10 (b10/t10)  
DIN 3210 **E** = Ø d10 (b10/t10)  
EN ISO 5210 **B 4** ≤ Ø dy

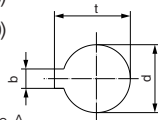
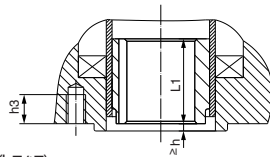

For missing dimensions, refer to type A

Dimensions		SA 07.2/SA 07.6			SA 10.2		SA 14.2/SA 14.6		SA 16.2	
EN ISO 5210	DIN 3210	F07	F10	G0	F10	G0	F14	G1/2	F16	G3
Ø d7 H9		28	42	42	42	42	60		80	
b7 JS9		8	12	12	12	12	18		22	
t7		31.3	45.3	45.3	45.3	45.3	64.4		85.4	
Ø d10 H9		16	20	20	20	20	30		40	
b10 JS9		5	6	6	6	6	8		12	
t10		18.3	22.8	22.8	22.8	22.8	33.3		43.3	
Ø dy H9 <sup>1)</sup>		25	35	35	35	35	45		60	
h3		12	13	13	15	15	25		30	
L1		35	45	45	45	45	65		80	

Dog coupling<sup>3)</sup>

Type  
DIN 3338 **C** = Ø d11

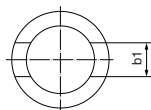
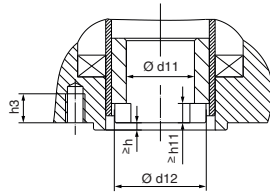

For missing dimensions, refer to type A

Dimensions		SA 07.2/SA 07.6			SA 10.2		SA 14.2/SA 14.6		SA 16.2	
EN ISO 5210	DIN 3210	F07	F10	G0	F10	G0	F14	G1/2	F16	G3
b1 H11		14 <sup>4)</sup>	14	14	14	14	20		24	
Ø d11 H11		28 <sup>4)</sup>	28	28	28	28	38		47	
Ø d11 min.		–	20	20	20	20	30		40	
Ø d11 max. <sup>2)</sup>		–	42	42	42	42	60		80	
Ø d12		36.8	51.8	51.8	51.8	51.8	73.8		98	
h3		12	13	13	15	15	25		30	
h11		7 <sup>4)</sup>	7	7	7	7	8		10	

Shaft end

Type  
DIN 3210 **D**

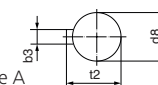
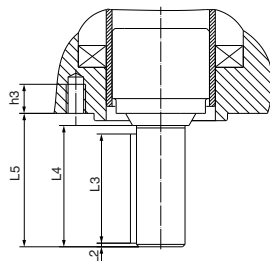

For missing dimensions, refer to type A

Dimensions		SA 07.2/SA 07.6			SA 10.2		SA 14.2/SA 14.6		SA 16.2	
EN ISO 5210	DIN 3210	F07	F10	G0	F10	G0	F14	G1/2	F16	G3
Ø d8 g6		20	20	20	20	20	30	30	40	40
b3 h9		6	6	6	6	6	8	8	12	12
h3		12	13	13	15	15	25	25	30	30
L2		1.5	1.5	1.5	1.5	1.5	2	2	3	3
L3		45	45	45	45	45	63	63	80	80
L4		50	50	50	50	50	70	70	90	90
L5		55	55	55	55	55	76	76	97	97
t2		22.5	22.5	22.5	22.5	22.5	33	33	43	43
Gewicht kg		0.4	0.4	0.4	0.7	0.7	2	2	4.3	4.3

1) Dimensions b, t depend on Ø d10/Ø dy, refer to DIN 6885-1

2) For rising valve stem Ø d11 max. = Ø d5 of type A

3) Weight included in actuator

4) Dimensions not complying with DIN 3338

5) Max. bore diameter in mm

We reserve the right to alter data according to improvements made. Previous documents become invalid with the issue of this document.